

## Thermoplastic Waterstops



Concerning the actual state of the DIBt (german institute of civil engineering) in consultation with the authorities of construction inspection of the federal states created building regulations, for protection against pressing water, not pressing water and soil humidity, it's only allowed to use waterstops in accordance with :

**DIN 18541** thermoplastic waterstops, weldable

or

**DIN 7865** Elastomeric waterstops, vulcanisable

or

**waterproofing systems** with AbP (general construction supervision certificate)

In DIN 18197 planning, dimensioning, conditioning, handling and the installation of waterstops are fixed.

**Our waterstops are available in two different material qualities:**

**LECOTRIL DIN 18541**  
**PVC-P-NBR combined polymerisat,**  
**compatible with bitumen (BV)**  
**external quality control by MPA NRW**

<b>physical properties (extraction)</b>	water stops, water stops for capping joints and profiles
Elongation at break at + 23° C	≥ 350 %
Tensile strength	≥ 10 MPa
Shore A-hardness	67 ± 5

**Standard specification with AbP (general construction supervision certificate)**  
**PVC-P not compatible with bitumen (NB)**  
**Internal quality control**

<b>physical properties (extraction)</b>	water stops, water stops for capping joints and profiles
Elongation at break at + 23° C	≥ 275%
Tensile strength	≥ 8 MPa
Shore A-hardness	75 ± 5



**Construction joint waterstops**

for sealing of construction joints in watertight concrete

Combination construction joint waterstops, (KAB...) floor/wall without floor setting edge	<b>page 4-5</b>
Construction joint waterstops, internal, reinforced, (SFA... / ISA ...)	<b>page 6</b>
Construction joint waterstops, internal, (A...)	<b>page 7</b>
Construction joint waterstops, external, (AA...)	<b>page 8-9</b>



**Joint tubes**

for precise controlling and sealing of shrinkage cracks in watertight concrete

Joint tubes, (Q 1, Q 2, DR 6)	<b>page 10-11</b>
-------------------------------	-------------------



**Expansion joint waterstops**

for sealing of expansion joints in watertight concrete

Waterstops for high demands (A...+ D...)	<b>page 12</b>
Expansion joint waterstops, internal, (D...)	<b>page 13-14</b>
Expansion joint waterstops, internal, reinforced, (SFD...)	<b>page 14</b>
Expansion joint waterstops, external, (DA...)	<b>page 15-16</b>
Waterstops for capping joints, (FA...)	<b>page 17-18</b>



**Compression seals**

Compression seals in PVC-P-NBR	<b>page 19</b>
Compression seals in synthesis rubber	<b>page 20</b>



**Special profiles**

Flanging profiles, (D 320 K, DA 320/30 K, FP 320, FP 360)	<b>page 21</b>
Membrane fixing profiles, (AA 60, AA 100, AA 140)	<b>page 21</b>

Sealing of pre - cast double walls	<b>page 22-23</b>
Waterstop intersection pieces and accessories	<b>page 24-25</b>
Examples of submission	<b>page 26-27</b>
General application instructions	<b>page 28-30</b>

**Information**

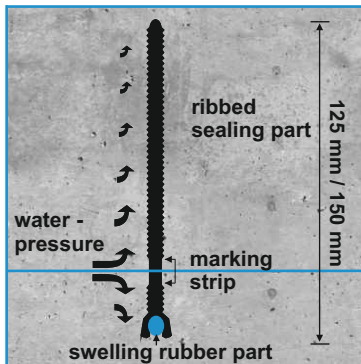

• **Functional principle**

The KAB - combination construction joint waterstop is a waterstop with an integrated TPE - round swelling rubber profile used for the sealing of construction joints in concrete structures. The KAB - combination construction joint waterstop consists of a PVC-P material and a splash water protected TPE - round swelling rubber profile at the bottom area. The sealing capabilities of the KAB - combination construction joint waterstop have been successfully tested and proven in practical use by employing concrete-encased test modules. Even under high water pressure both sealing elements - ribbed sealing and swelling profile - have proven to function in an impressive way without failure. The KAB - combination construction joint waterstops are used successfully for years to seal waterproof concrete structures.

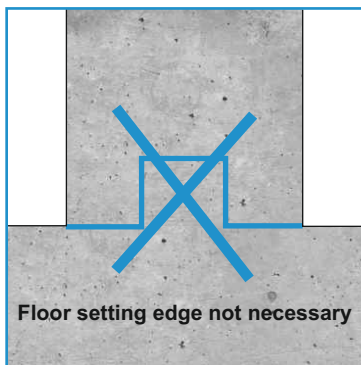

The KAB - combination construction joint waterstop is distinguished by cost effectiveness, easy installation and reliability.

- ✗ Without floor setting edge or adaptation in the reinforcement of floor sections
- ✗ with AbP (General Construction Supervision Certificate)
  - to be used for sealing of construction joints in concrete constructions at distribution pressures up to 2 bar respectively 20 m water column
  - The KAB - combination construction joint waterstop is suitable for alternating water contact. The sealing fits the requirements of use class A according to WU-Richtlinie
- ✗ Easy, quick and reliable laying
  - high inherent stability
  - coils of 25 m length which means less jointing
  - small bend radius (edges can be bent)
  - low weight (one 25 m coil is about approx. 25 kg)
  - no risk of injuries by sharp edges

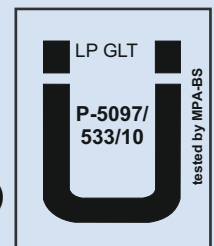

• **Application instructions (floor / wall)**

The swelling rubber part of profile prevents the water from intruding into the bottom area, the ribbed part of profile prevents the water from intruding into the wall area.

- ✗ the KAB has to be installed directly on the bottom reinforcement by using steel bars at a distance of 0,5 m.
- ✗ the KAB/F is additionally stabilized by inner flat spring steel. Therefore the distance between the attached steel bars could be expanded. The distance of 1,0 m causes a lower effort for laying.

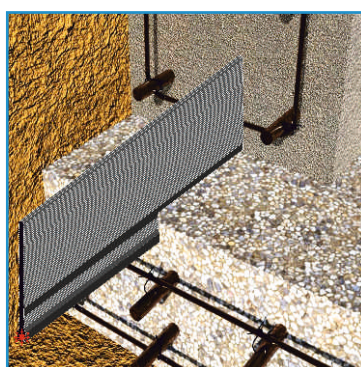



X The marking strip of 1,5 cm width is located at a height of 3,0 cm up to 4,5 cm and serves as an installation control. The max. linking depth of the profile bottom with the swelling rubber is 4,5 cm.

X Joints can be connected and installed in different ways:

- With terminal strips, which were especially developed for combination construction joint waterstops. Basic principle are 3 TPE - swelling rubber profiles with a capacity for high volume expansion and terminal strips of 2 mm thickness, which will be connected with the punched waterstop by butterfly nuts. For punching the waterstop, the terminal strip will be used as a template (5 mm drill bit). The swelling rubber profiles will be delivered prepunched and should be stuck together as pictured leftside. The butterfly nuts should be fixed hand - screwed.
- Butt joint weldings with an axe shaped welding tool (the swelling rubber profile can be taken out of the notch in the welding area temporarily, to replace it, after the welding, in the cleaned notch).
- Overlapping welding with hot air blower. The overlap should be 5 cm and the riffle must be deleted on the whole width. The contact surfaces are melting by the hot air concurrently and have to be pressed against each other.

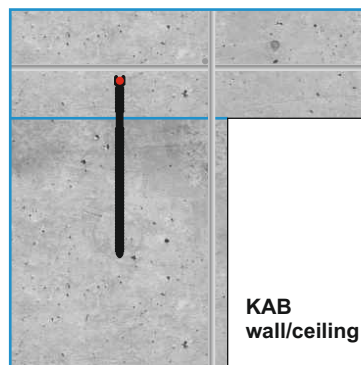
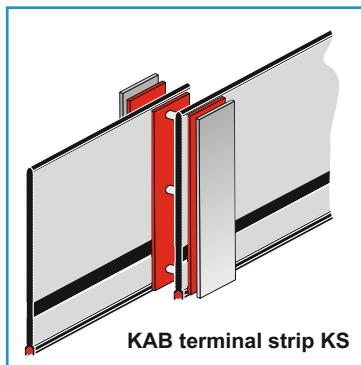

• **Application instructions (wall / ceiling)**

The long part of profile, has to be pushed into the fresh concrete, up to the marking strip, on the top of the wall, during the first concrete pour section. After this, the concrete has to be compressed. The swelling rubber profile must be covered, until, the ceiling concrete pour will take place, to avoid a swelling ahead of time due to rain.

• **NEW combination construction joint waterstop with spring steel (KAB/F) !**

The combination construction joint waterstop could be delivered with an especially hardened spring steel. The stability of KAB will be increased seriously and the concreting will be more reliable. Installation time could be reduced by the need of only one steel bar per meter due to the higher stability.

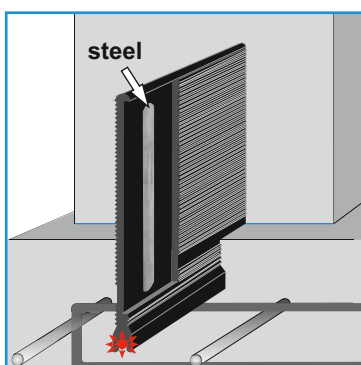

• **Storage**

The swelling rubber is activated by water contact. Therefore, it is important to provide storage in a dry place away from moisture.

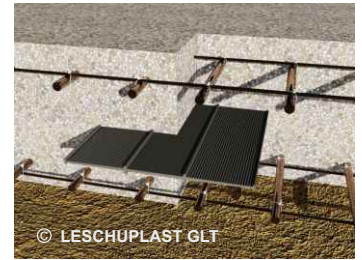

SFA 190\*

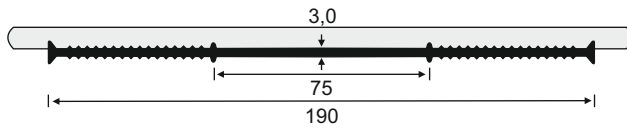

SFA 240

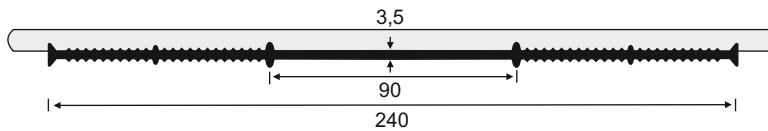

SFA 320

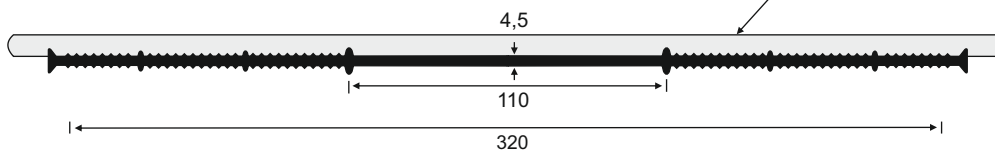

reinforcing by harder  
adjusted PVC P cords

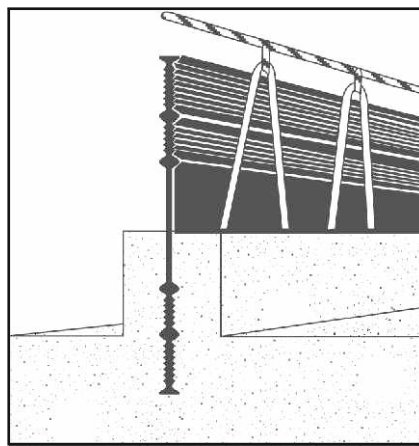
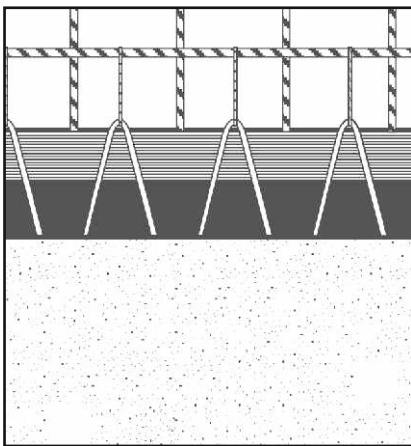

Construction joint waterstops with fixing loops are reinforced one - sided with harder adjusted PVC P cords and have fixing loops on both edges of the waterstop. The protruding loops are for fastening the waterstop to the reinforcement (clamps are not required).

Construction joint waterstops, internal,  
with internal flat steel bar - reinforcement,  
black, LECOTRIL DIN 18541

ISA/F 190\*

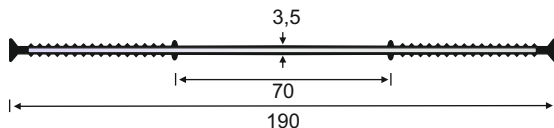

ISA/F 240

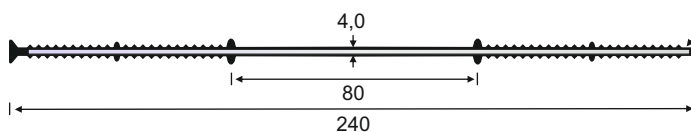

ISA/F 320

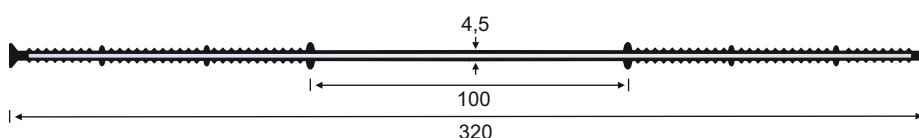

reinforcing by internal  
flat steel bar

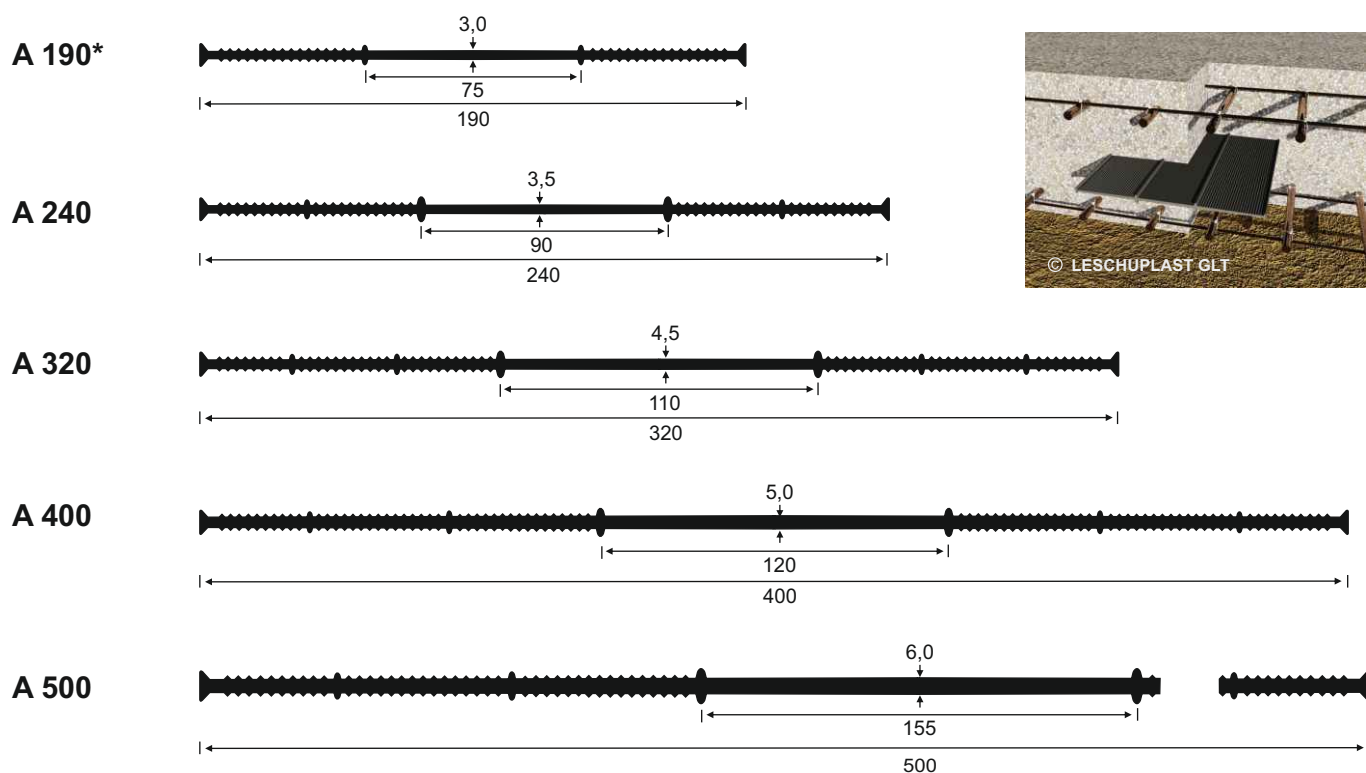

**Construction joint waterstops, internal, black, Standard Specification with AbP**

PVC-P Standard Specification	total width	width of expansion part	thickness of expansion part	comparable profiles according to DIN 18541
A 10	100	43	3,0	
A 15	150	45	3,0	
A 19	190	75	3,0	A 190*
A 24	240	85	3,5	A 240
A 32	320	110	4,5	A 320
A 40	400	120	5,0	A 400
A 50	500	160	6,0	A 500
SFA 10	100	43	3,0	
SFA 15	150	45	3,0	
SFA 19	190	75	3,0	SFA 190*
SFA 24	240	85	3,5	SFA 240
SFA 32	320	110	4,5	SFA 320
ISA/F 10	100	40	3,0	
ISA/F 15	150	53	3,0	
ISA/F 19	190	70	3,0	ISA/F 190*
ISA/F 24	240	80	3,5	ISA/F 240
ISA/F 32	320	100	4,5	ISA/F 320

\* DIN 18541, part 2

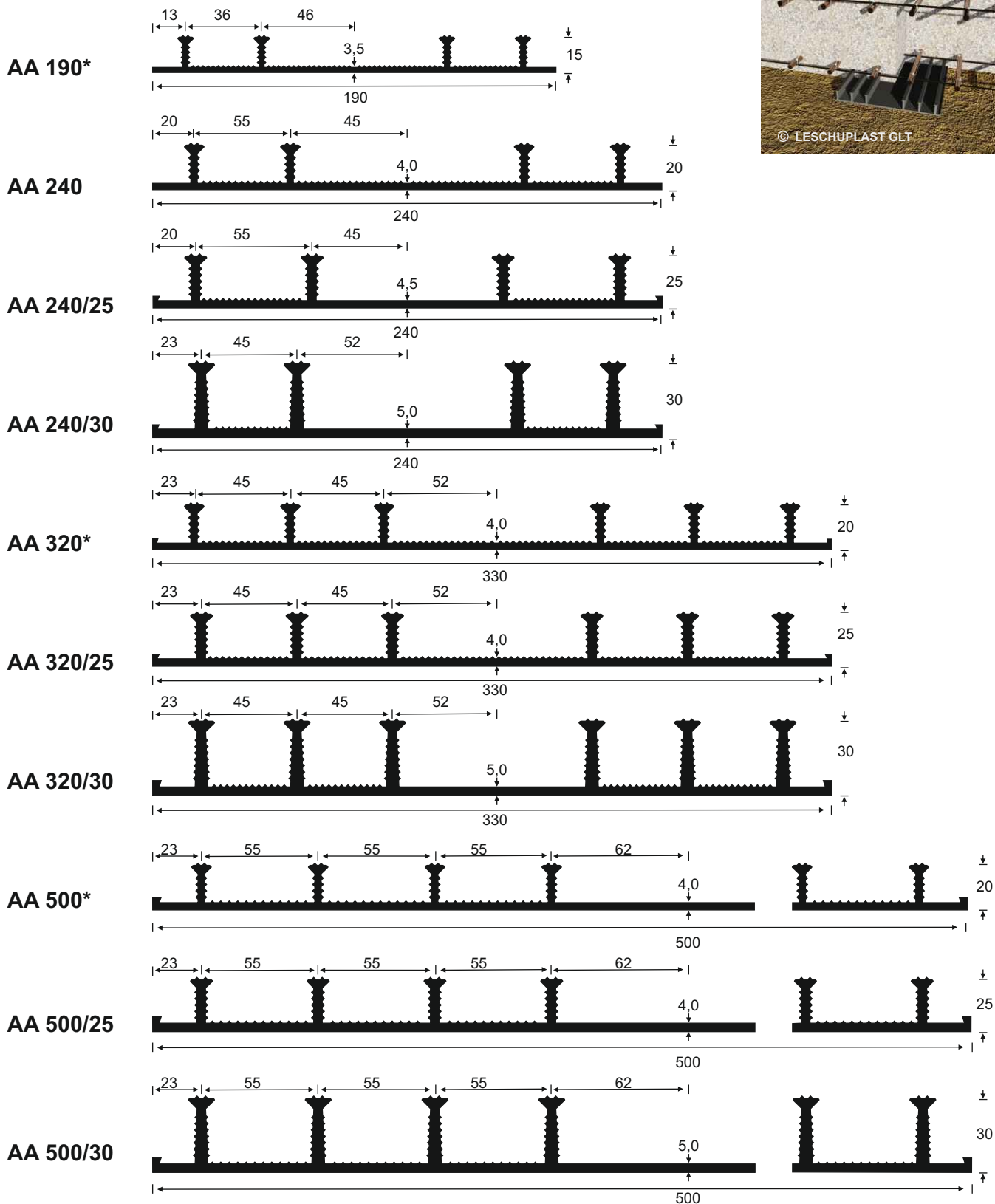

\* DIN 18541, part 2



without illustration:  
anchoring ribs internal

**AA 240 Ecke\***

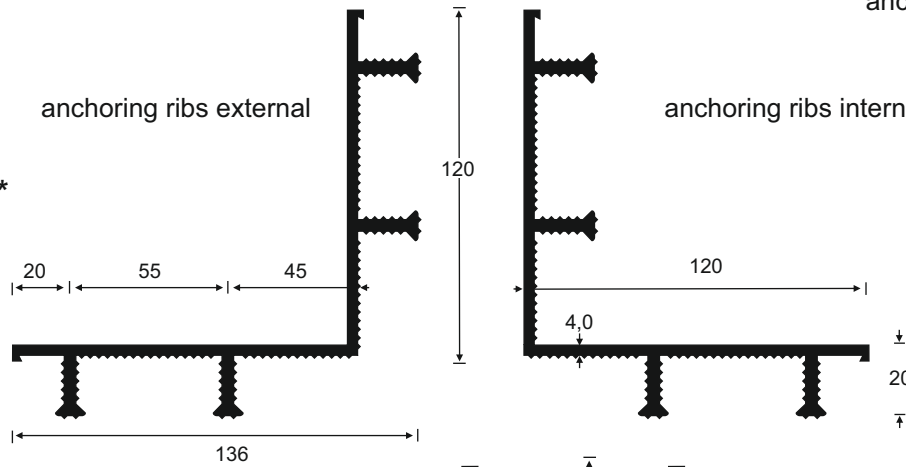

without illustration:  
anchoring ribs internal

**AA 320 Ecke\***

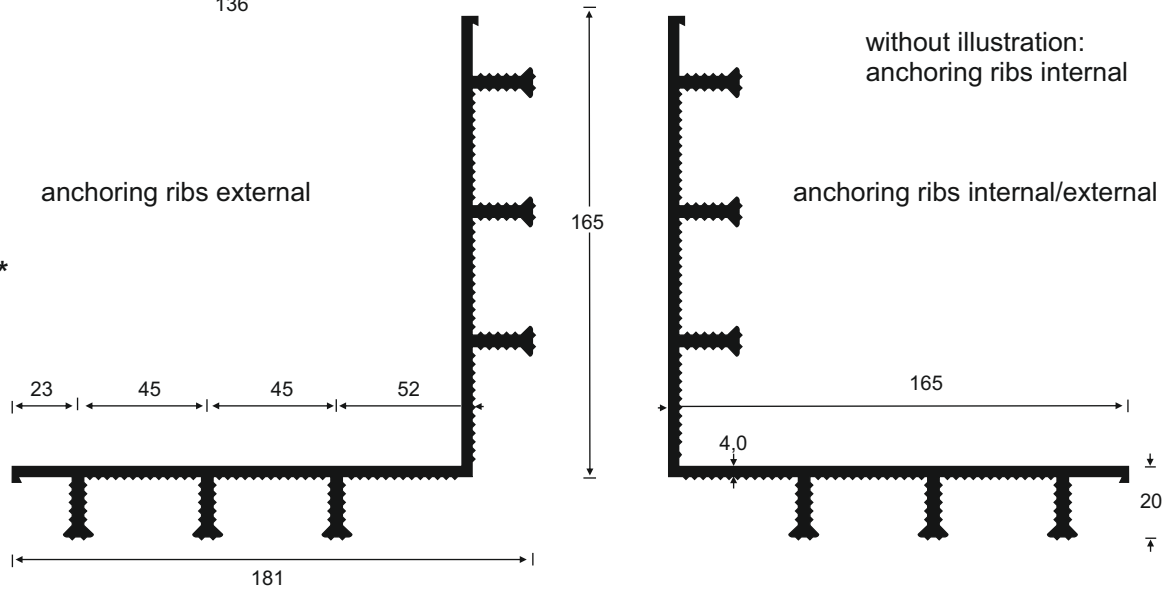

**Construction joint waterstops, external, black, Standard Specification with AbP**

PVC-P Standard Specification	total width	width of expansion part	thickness of expansion part	anchoring ribs		comparable profiles according to DIN 18541
				height	quantity	
AA 19	190	92	3,0	15	4	AA 190*
AA 24	240	110	4,0	20	4	AA 240
AA 24/2	240	90	4,0	25	4	AA 240/25
AA 24/3	240	104	4,0	30	4	AA 240/30
AA 32	330	110	4,0	20	6	AA 320*
AA 32/2	330	104	4,0	25	6	AA 320/25
AA 32/3	330	104	4,0	30	6	AA 320/30
AA 50	500	124	4,0	20	8	AA 500*
AA 50/2	500	124	4,0	25	8	AA 500/25
AA 50/3	500	124	4,0	30	8	AA 500/30

\* DIN 18541, part 2

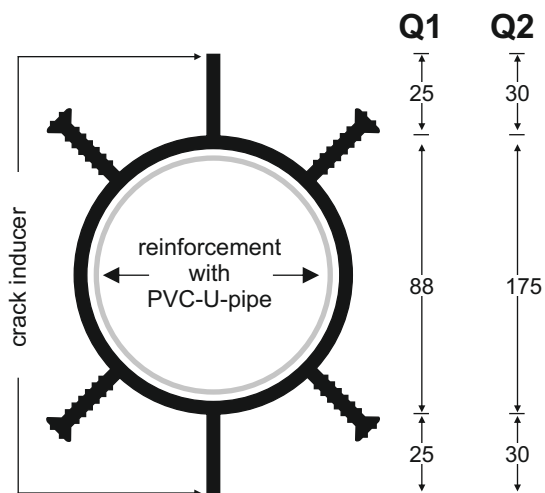

- controlling of cracks (predetermined breaking point)
- sealing of cracks by anchoring ribs
- quick and efficient installation
- performance-proven by long experience

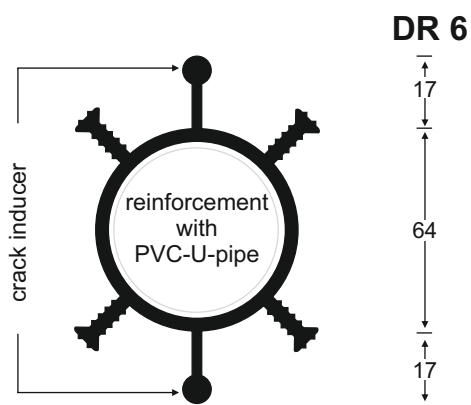

- Q 1** for concrete cross sections from 24 up to 35 cm
- Q 2** for concrete cross sections from 35 up to 50 cm
- DR 6** for concrete cross sections from 17 up to 24 cm (especially for pre-cast double walls)

**Installation example**

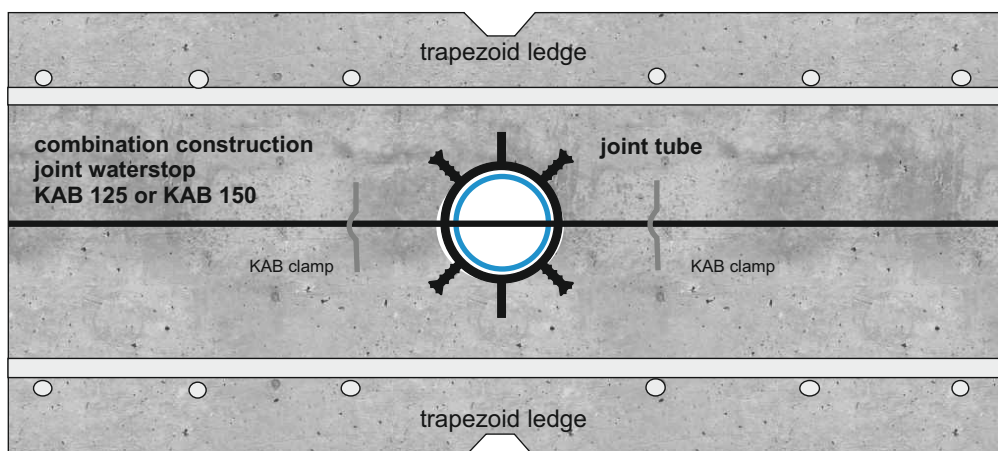

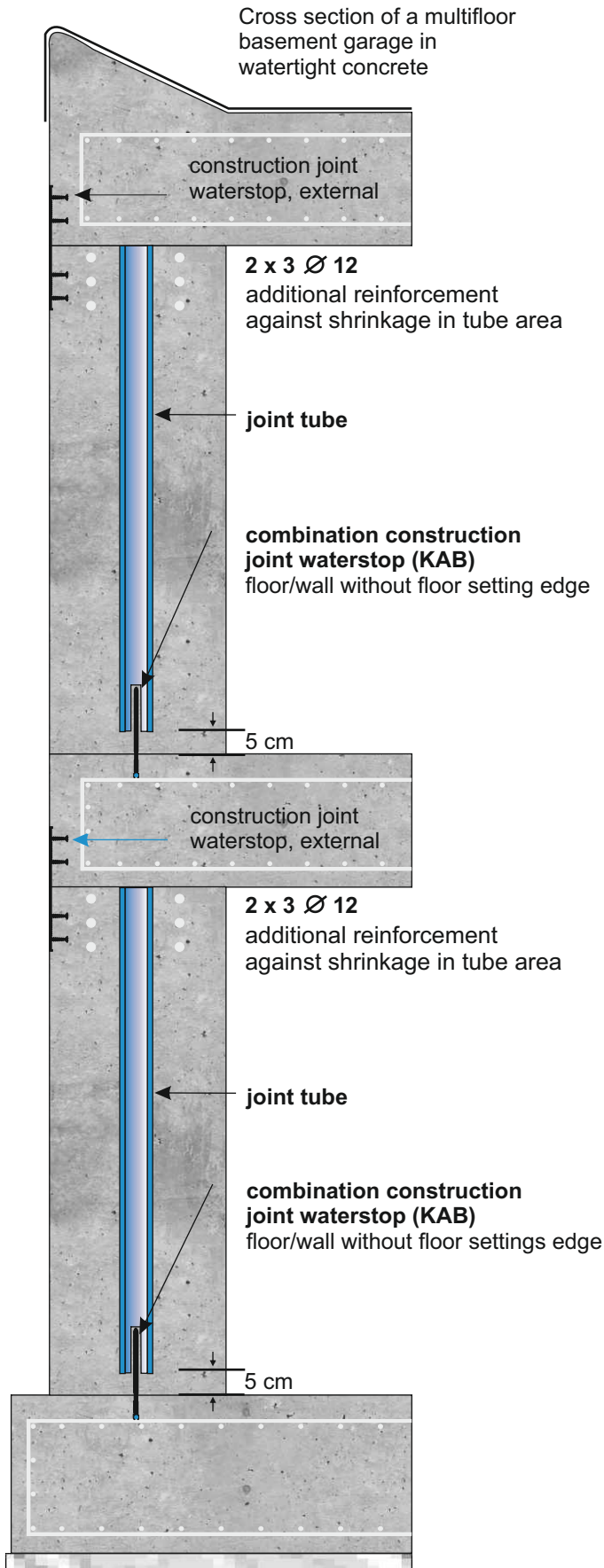

## Installation instructions

Before installation, the joint tube has to be cut in-across to the smooth crack inducer. The joint tube has to be cut into lengths according to total height of the walls, on building site.

Attaching the joint tube on top of KAB, which is installed for sealing the connection floor level/wall. Pay special attention to ensure a distance of approx. 5 cm between the bottom line of the joint tube and the horizontal construction joint.

During installation, the joint tube has to be fixed on the top by clamps, at the anchoring ribs.

Concrete has to be brought into the formwork evenly and simultaneous on both sides of the joint tube.

Extraction of the inner pipe after concreting should not take place.

The joint tube has to be filled with concrete during or after concreting the wall.

## Advantages and description of function

- ✗ Controlled shrinkage cracking by reducing the cross section.
- ✗ Sealing of the shrinkage crack by anchoring ribs of the tube.
- ✗ Walls are force - fit, because the necessary static reinforcement won't be interrupted.
- ✗ Low wage costs for installation.
- ✗ It's possible to concrete large wall sections of any length.

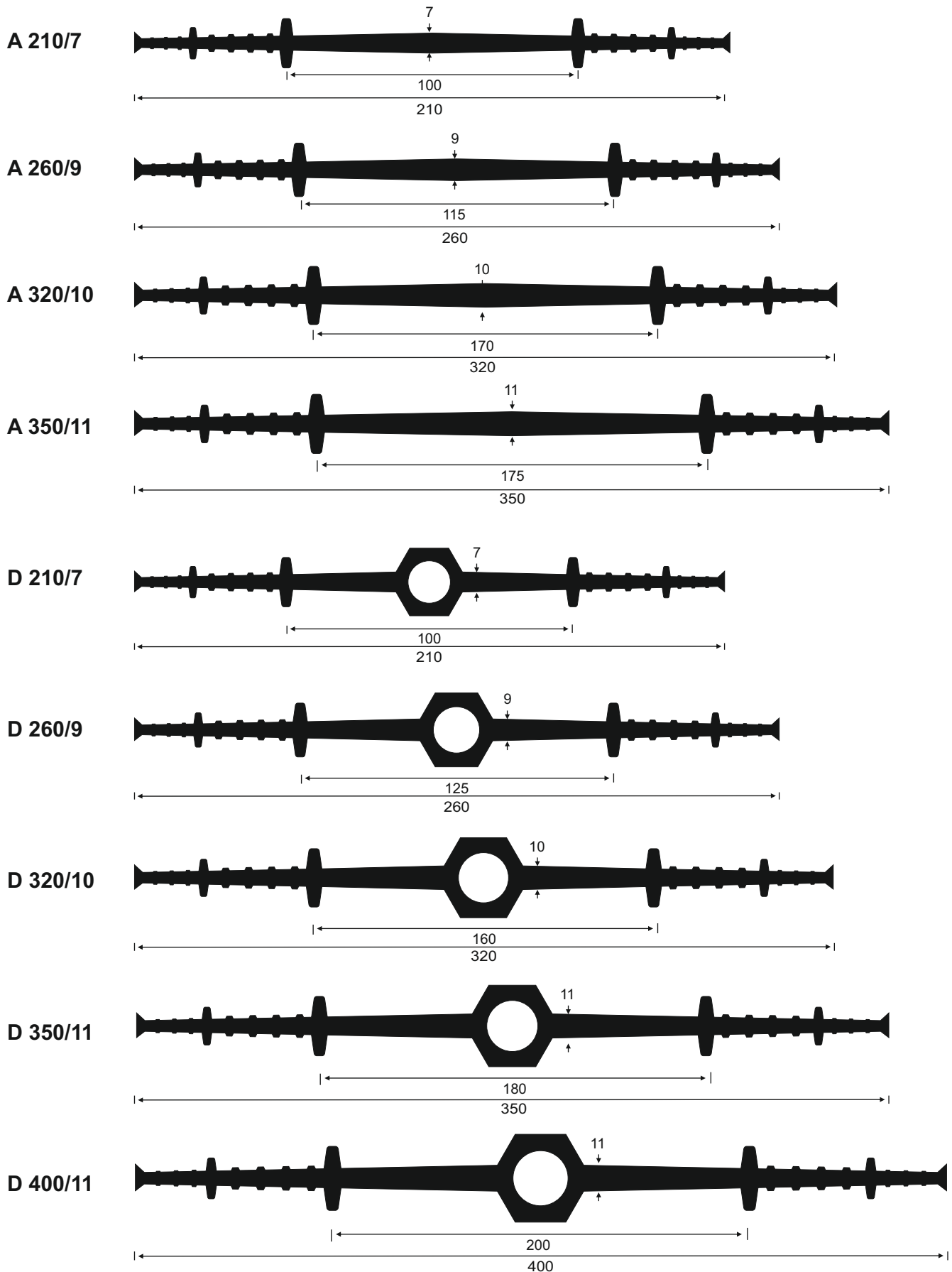

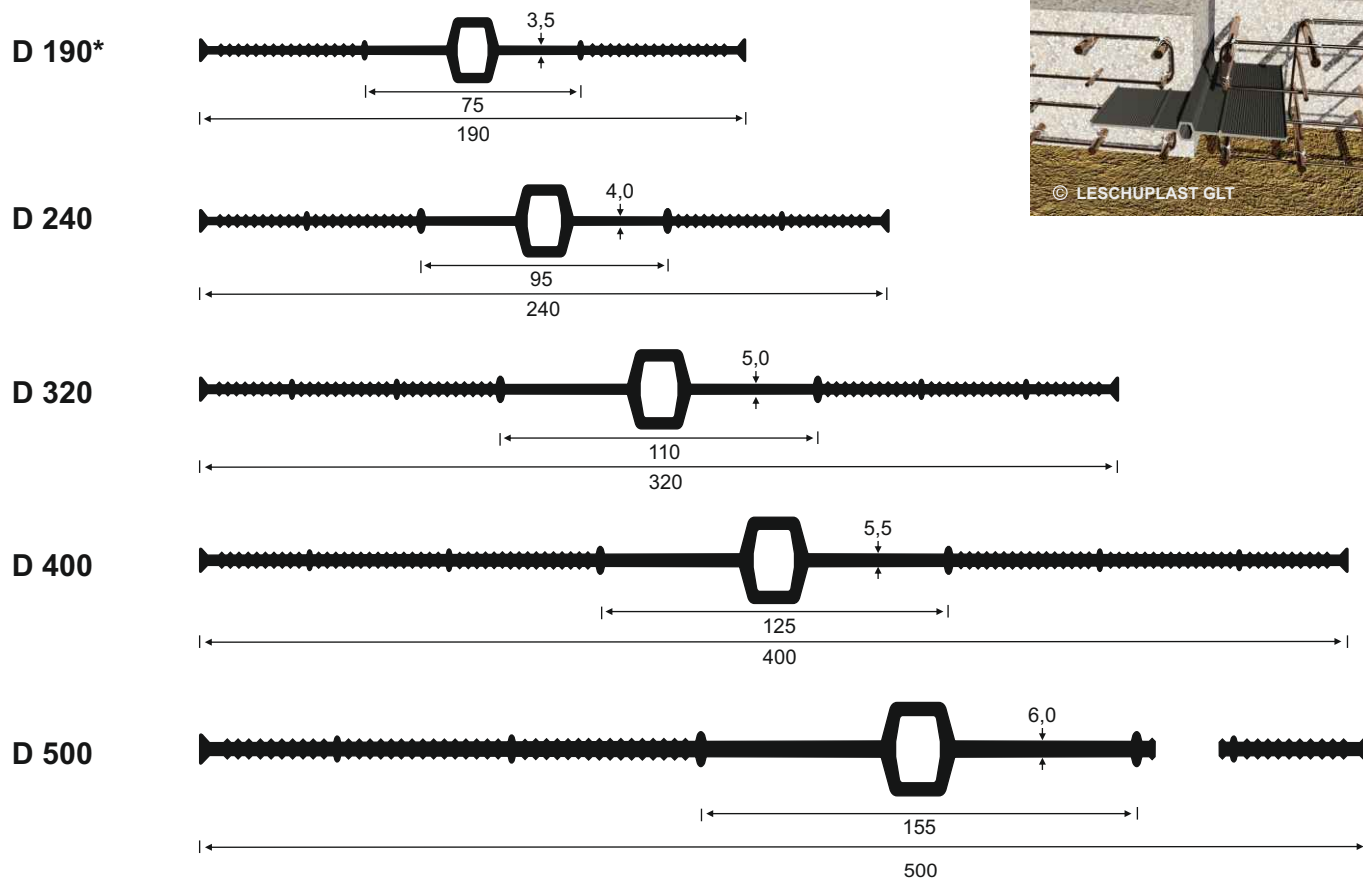

**Expansion joint waterstops, internal, black, Standard Specification with AbP**

PVC-P Standard Specification	total width	width of expansion part	thickness of expansion part	comparable profiles according to DIN 18541
D 10	100	40	3,0	
D 15	150	50	3,0	
D 19	190	75	3,0	D 190*
D 24	240	85	4,0	D 240
D 32	320	110	5,0	D 320
D 40	400	125	5,5	D 400
D 50	500	160	6,0	D 500
D 25/6	250	120	6,0	D 250/6
D 32/6	320	170	6,0	D 320/6
D 25/9	250	120	9,0	D 250/9
D 32/9	320	120	9,0	D 320/9
SFD 24	240	85	4,0	SFD 240
SFD 32	320	110	4,5	SFD 320

\* DIN 18541, part 2



**D 250/6**

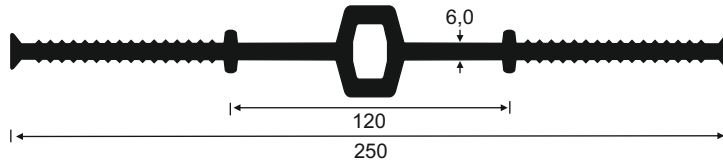

**D 320/6**

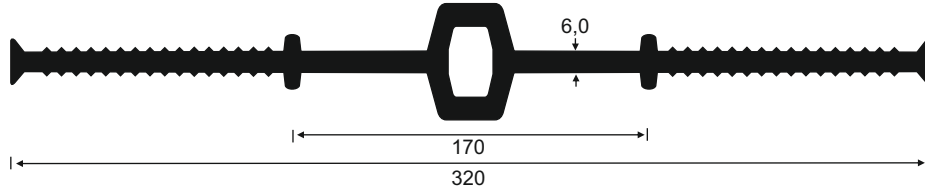

**D 250/9**

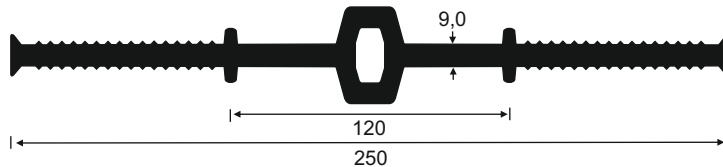

**D 320/9**

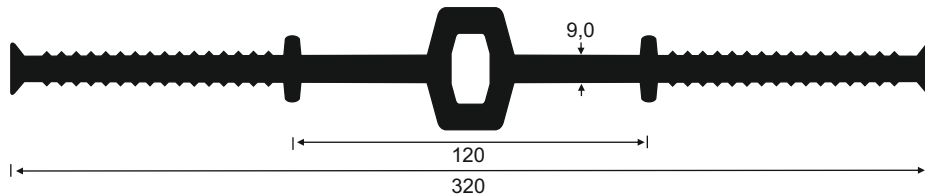

**Expansion joint waterstops, internal,  
with extruded reinforcement and  
fixing loops, black, LECOTRIL DIN 18541**

**SFD 240**

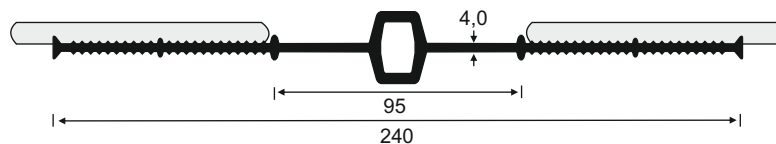

**SFD 320**

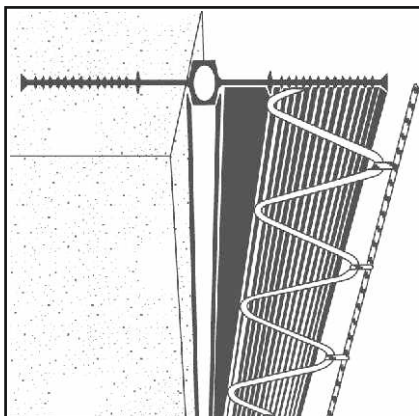
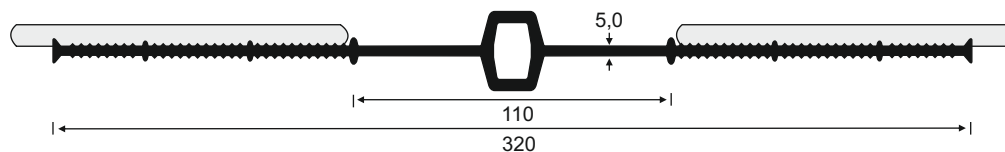

The expansion joint waterstops with fixing loops are reinforced one - sided with harder adjusted PVC - P cords and have fixing loops on both edges of the waterstop.

The PVC - loops consist of high impact resisting harder adjusted PVC - P. They have a thickness of 6 mm and stabilise the waterstop. The loops are arranged outside the expansion part, which keeps the expansion part free.

- reliable fastening
- quick installation
- high inherent stability
- good welding quality

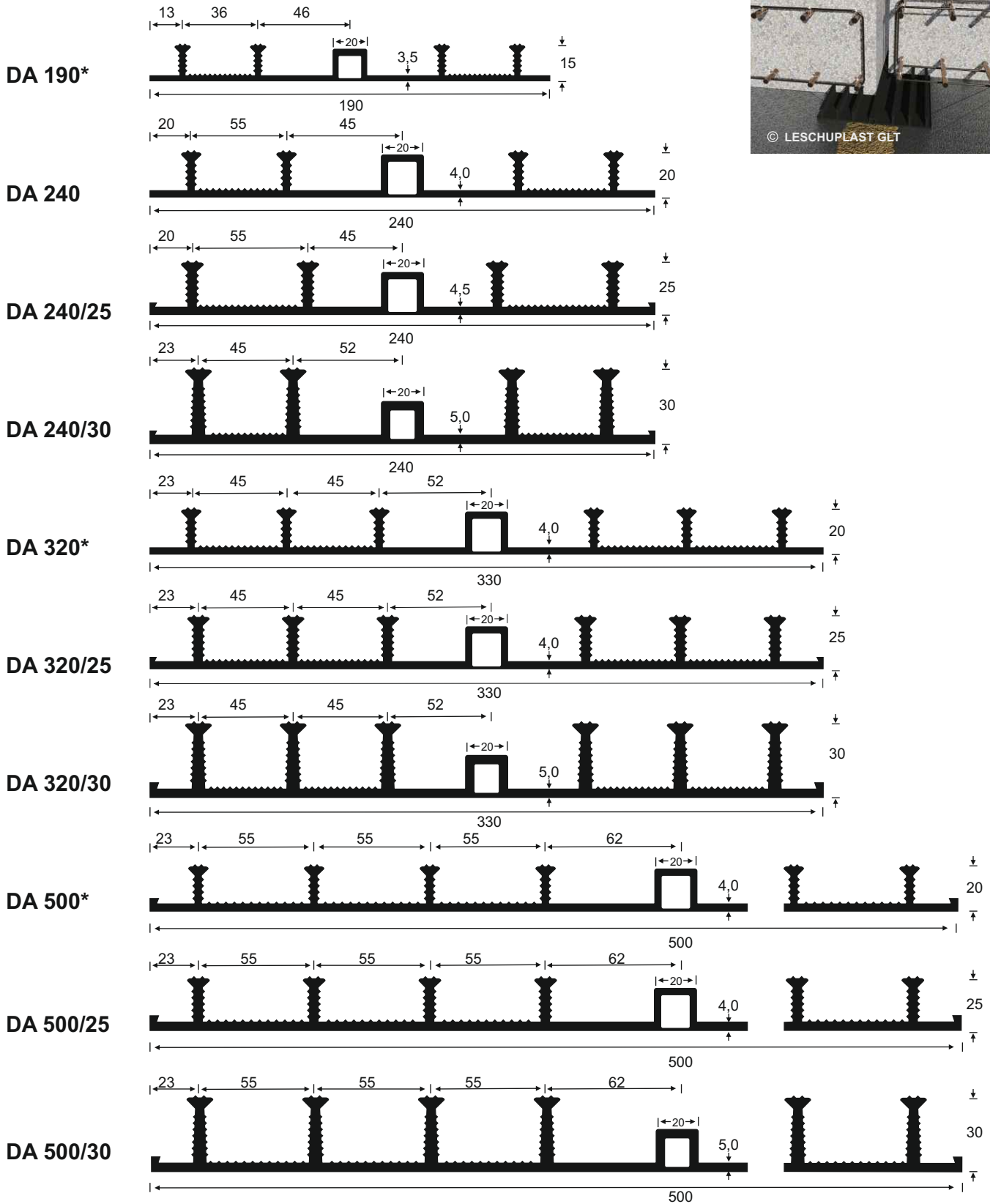

\* DIN 18541, part 2

DA 240 Ecke\*

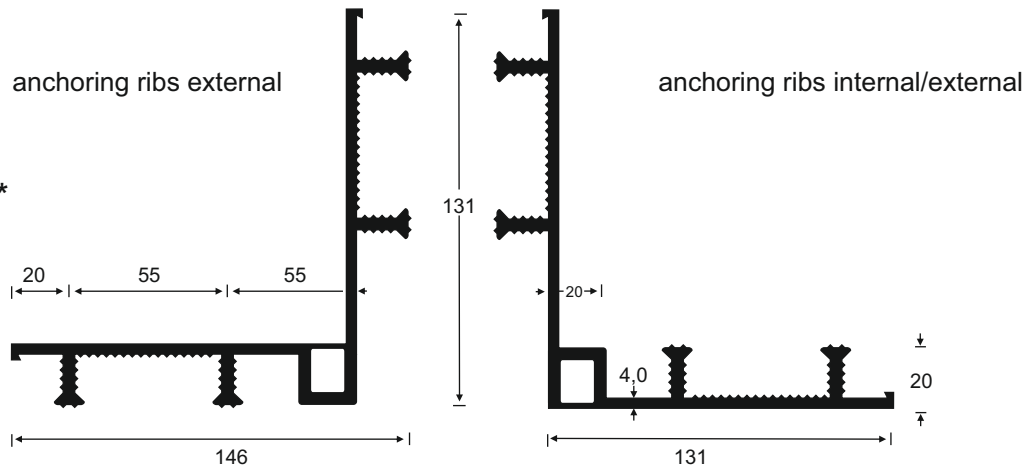

DA 320 Ecke\*

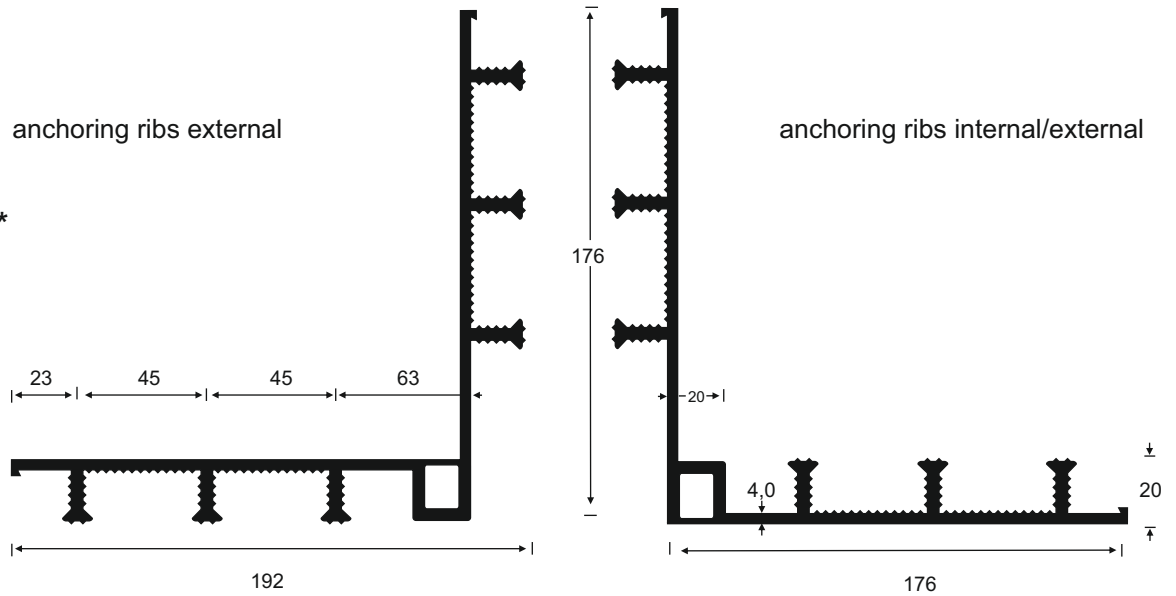

**Expansion joint waterstops, external, black, Standard Specification with AbP**

PVC-P Standard Specification	total width	width of expansion part	thickness of expansion part	anchoring ribs height	quantity	comparable profiles according to DIN 18541
DA 19	190	92	3,0	15	4	DA 190*
DA 24	240	110	4,0	20	4	DA 240
DA 24/2	240	90	4,0	25	4	DA 240/25
DA 24/3	240	104	4,0	30	4	DA 240/30
DA 32	330	110	4,0	20	6	DA 320*
DA 32/2	330	104	4,0	25	6	DA 320/25
DA 32/3	330	104	4,0	30	6	DA 320/30
DA 50	500	124	4,0	20	8	DA 500*
DA 50/2	500	124	4,0	25	8	DA 500/25
DA 50/3	500	124	4,0	30	8	DA 500/30

\* DIN 18541, part 2



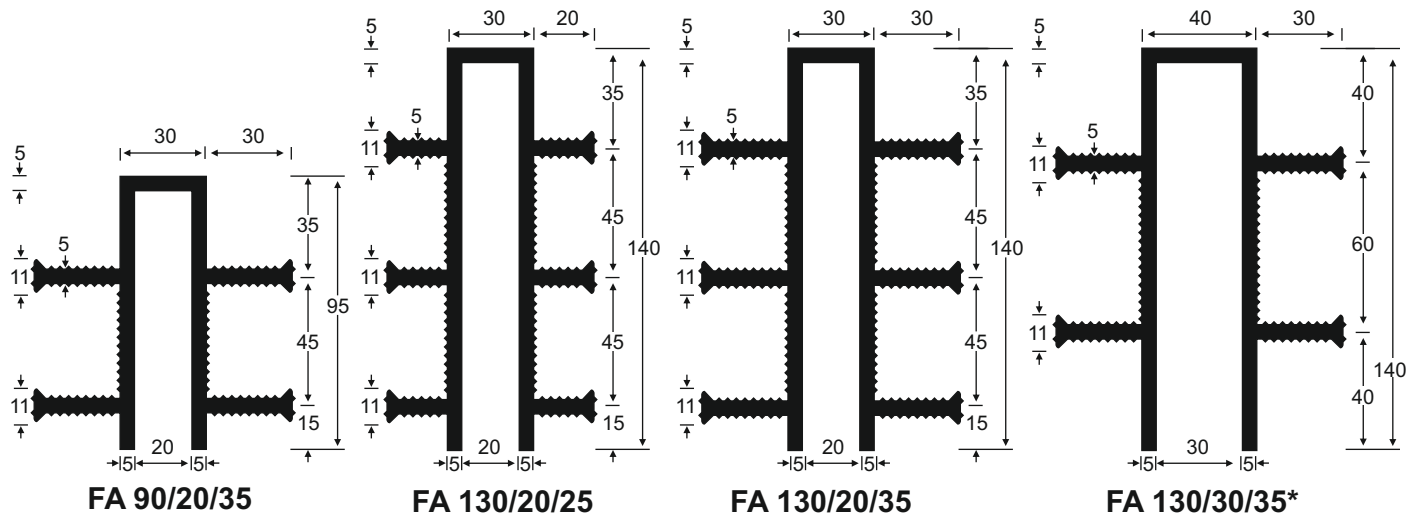
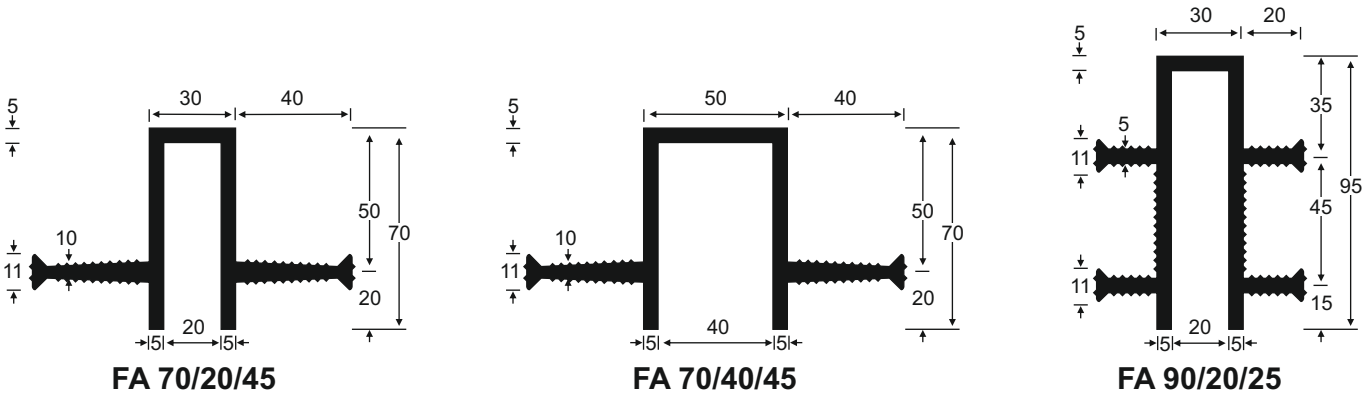
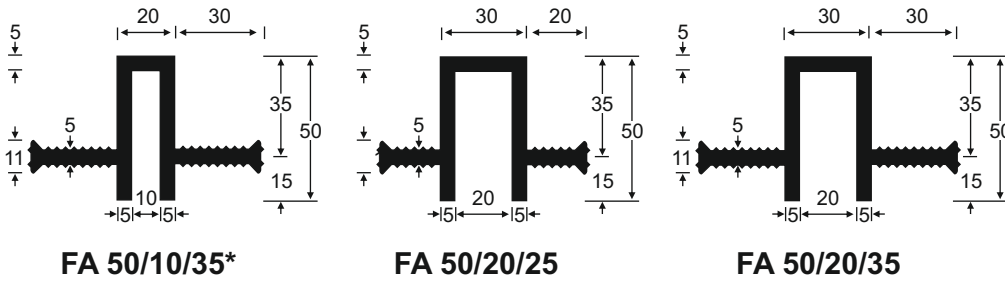

**Waterstops for capping joint, grey, Standard Specification**

PVC-P Standard Specification	total height	width of cover plate	width of joints	thickness of cover plate	anchoring ribs height	anchoring ribs quantity	comparable profiles according to DIN 18541
FA 5/1/2	50	20	10	5	20	2	FA 50/10/25*
FA 5/1/3	50	20	10	5	30	2	FA 50/10/35*
FA 5/2/2	50	30	20	5	20	2	FA 50/20/25
FA 5/2/3	50	30	20	5	30	2	FA 50/20/35
FA 7/2/4	70	30	20	5	40	2	FA 70/20/45
FA 7/4/4	70	50	40	5	40	2	FA 70/40/45
FA 9/2/2	95	30	20	5	20	4	FA 90/20/25
FA 9/2/3	95	30	20	5	30	4	FA 90/20/35
FA 13/2/2	140	30	20	5	20	6	FA 130/20/25
FA 13/2/3	140	30	20	5	30	6	FA 130/20/35
FA 13/3/3	140	40	30	5	30	4	FA 130/30/35*

\* DIN 18541, part 2

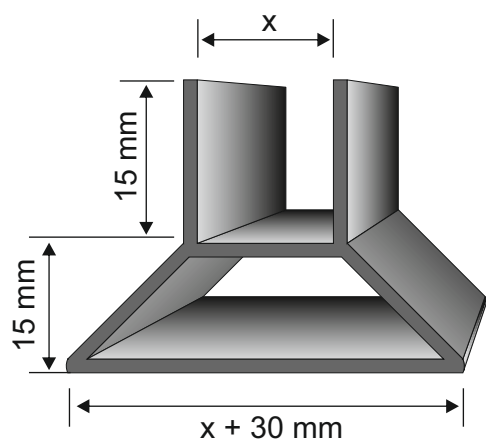

The trapezoid bar TFA facilitates the installation of a waterstop for capping joints in a space joint respectively dummy joint with conical edges of 1,5 cm. The trapezoid bar substitutes the conventional triangular ledge for the chamfer of the joints edges.

Material: rigid PVC

**TFA 20:** for waterstops for capping joints with 20 mm sight width; joint width 10 mm

**TFA 30:** for waterstops for capping joints with 30 mm sight width; joint width 20 mm

**TFA 40:** for waterstops for capping joints with 40 mm sight width; joint width 30 mm

**TFA 50:** for waterstops for capping joints with 50 mm sight width; joint width 40 mm

Appearance: rods of 2,5 m length

### X Application instruction

The trapezoid bar has to be nailed on the formwork and the waterstop for capping joints stuck into the bar. The waterstop has to be fixed with the stop end of the formwork respectively the joint filling plate inside the trapezoid bar.

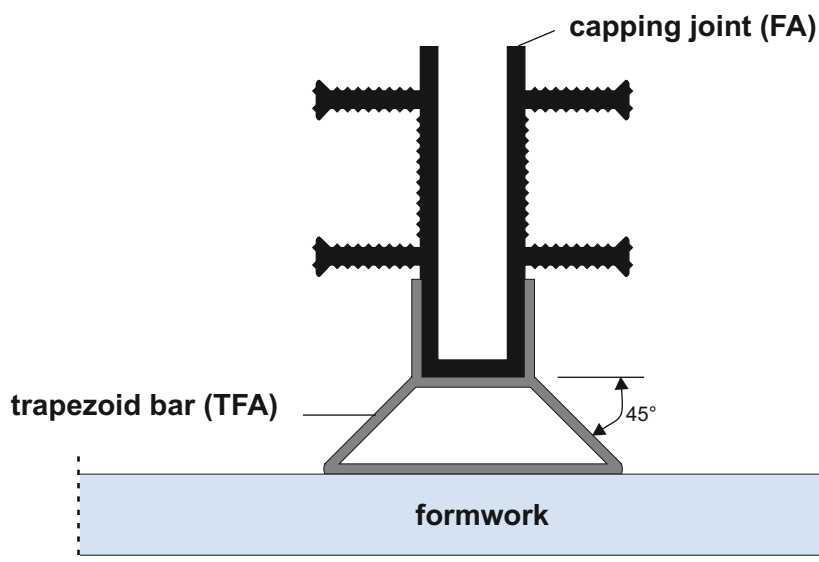

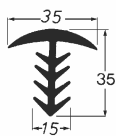

**EP 35/35/15**  
 (for 10 mm joints)

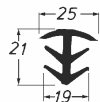

**EP 21/25/19**  
 (for 10-12 mm joints)

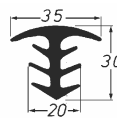

**EP 30/35/20**  
 (for 15 mm joints)

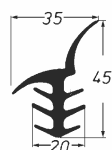

**EP 45/35/20 Eck**  
 (for 15 mm joints)

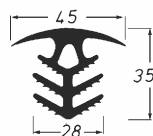

**EP 35/45/28**  
 (for 20 mm joints)



**EP 35/28/28 Eck**  
 (for 20 mm joints)

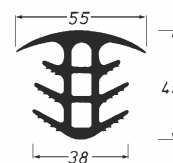

**EP 45/55/38**  
 (for 30 mm joints)

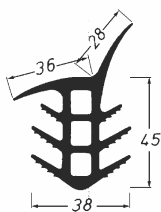

**EP 45/36/38 Eck**  
 (for 30 mm joints)

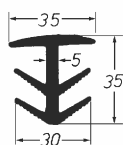

**EP 35/35/30**  
 (for 20 mm joints)

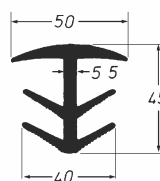

**EP 45/50/40**  
 (for 30 mm joints)

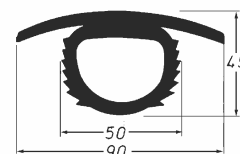

**S 45/50/90**  
 (for 30-40 mm joints)

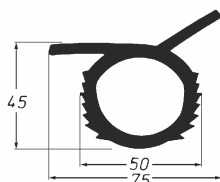

**S 45/50/75 Eck**  
 (for 30-40 mm joints)



**KA 22/21**  
 (for 15 mm joints)



**KA 22/24**  
 (for 18 mm joints)

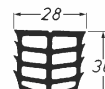

**KA 30/28**  
 (for 22 mm joints)

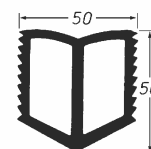

**F 50/50**  
 (for 30-40 mm joints)

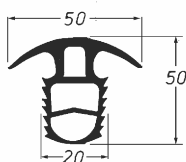

**S 20/50**  
 (for 20 mm joints)

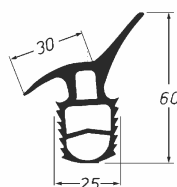

**S 20/50 Eck**  
 (for 20 mm joints)

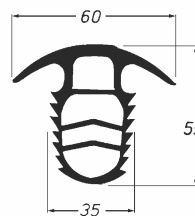

**S 30/60**  
 (for 30 mm joints)

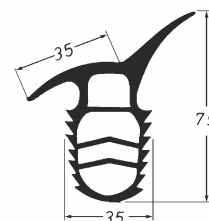

**S 30/60 Eck**  
 (for 30 mm joints)

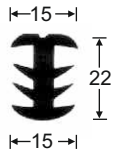

**BN 10**  
(for 8-13 mm joints)

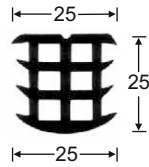

**BN 15**  
(for 13-20 mm joints)

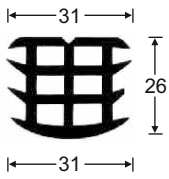
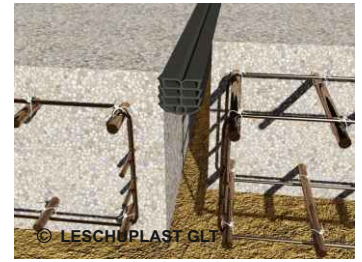

**BN 20**  
(for 20-26 mm joints)

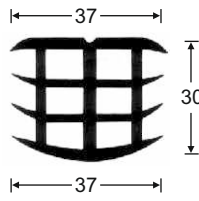

**BN 25**  
(for 25-32 mm joints)

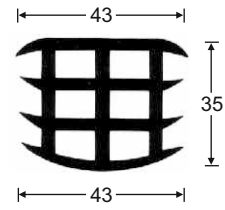

**BN 30**  
(for 30-38 mm joints)

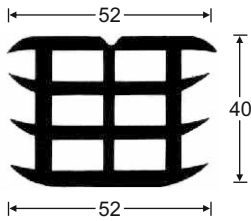

**BN 40**  
(for 37-43 mm joints)

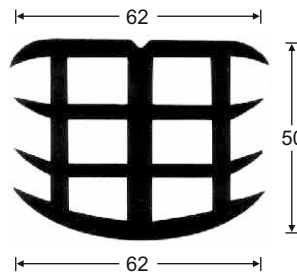

**BN 50**  
(for 43-52 mm joints)

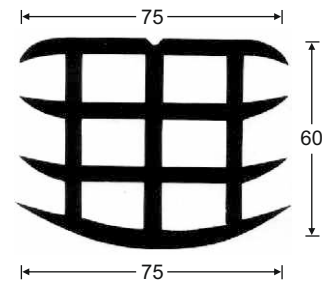

**BN 60**  
(for 50-65 mm joints)

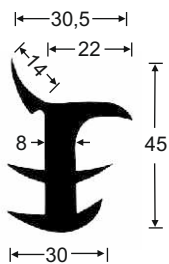

**KE 1 corner**  
(for 15-25mm joints)

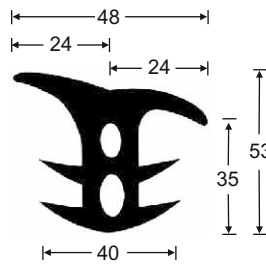

**KE 3 corner**  
(for 23-34mm joints)

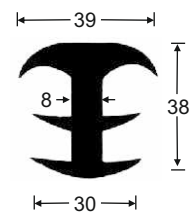

**KE 2**  
(for 15-25 mm joints)

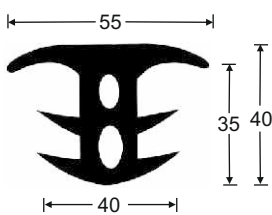

**KE 4**  
(for 23-34 mm joints)

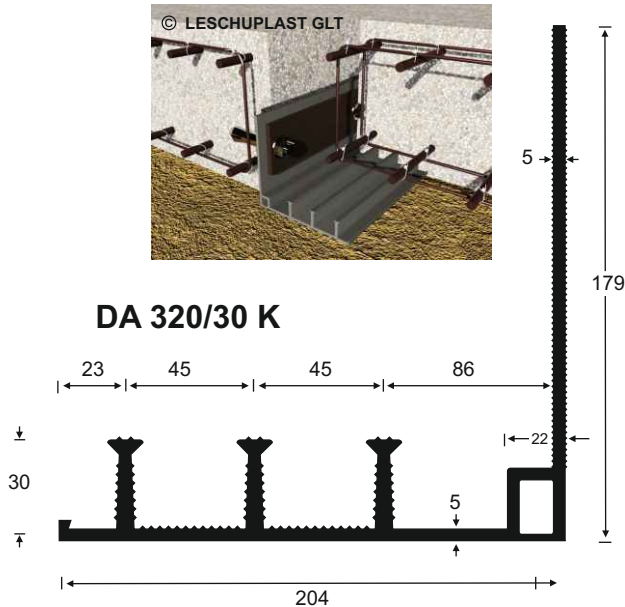
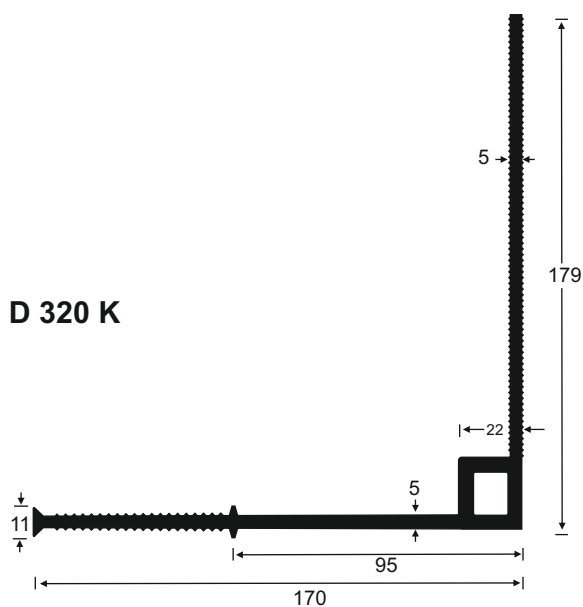
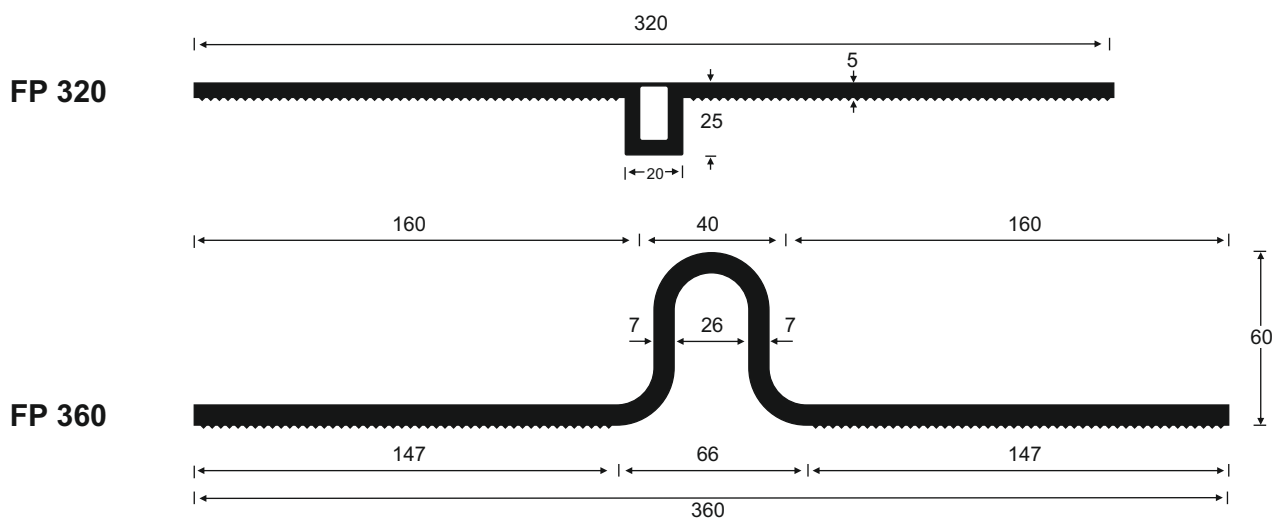

**Anschweißprofile**  
schwarz, LECOTRIL DIN 18541, Teil 2

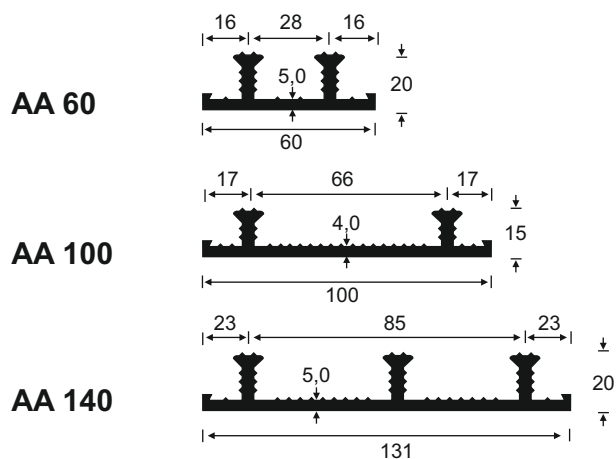

- Other geometries of profiles are available on request.
- Other materials, adjusted to the sealing membran are possible.

- ① Joint tube DR 6
- ② Combination construction joint waterstop KAB 125/150
- ③ Steel bars for installation

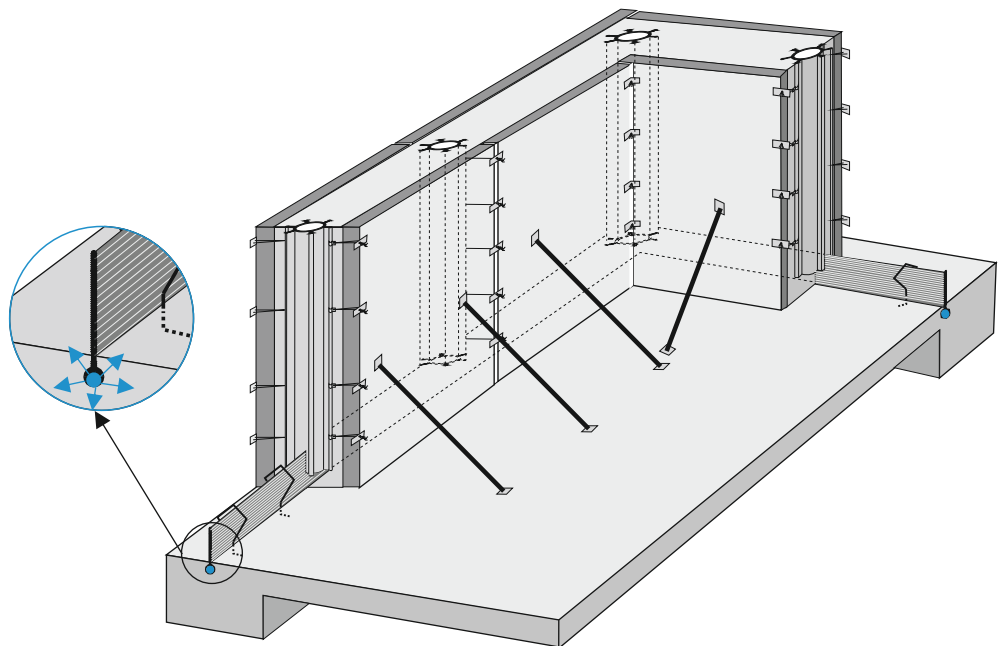
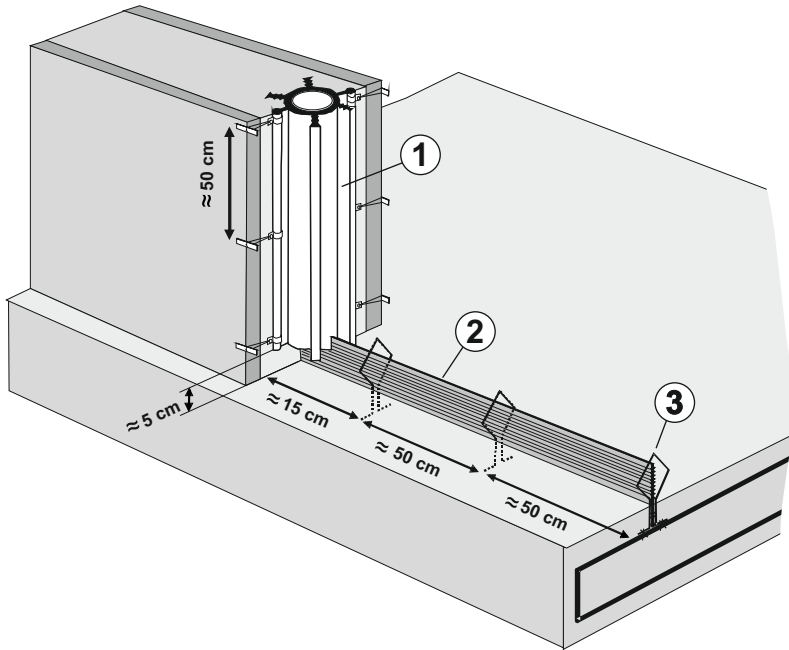

**System description**

Sealing of horizontal construction joints:

Combination construction joint waterstop  
KAB 125/150

Sealing of vertical butt joints:

Joint tube DR 6

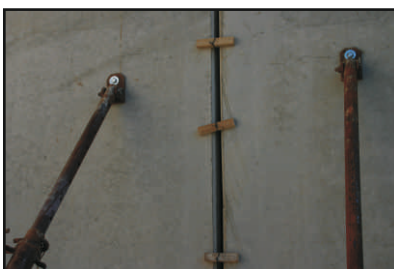
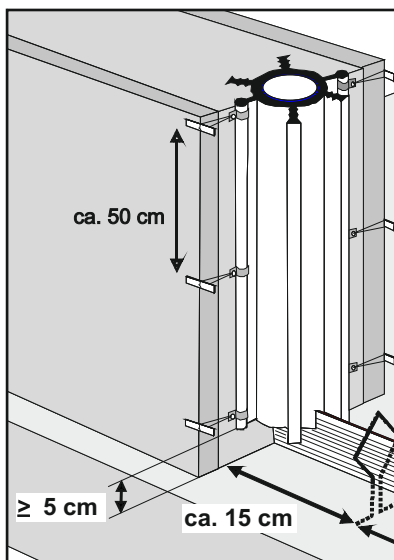
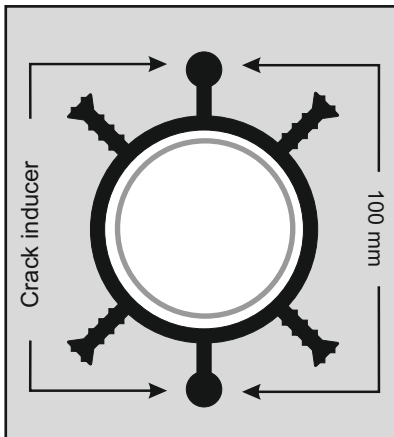

- ✘ During transport and storage the joint tubes have to be kept clean and protected from damage. For prevention of deformations, joint tubes should be stored on a flat surface area.
- ✘ Before installation, the joint tube has to be cut in-across to the smooth crack inducer with side bead. The joint tube has to be cut, to fit the total height of the walls on building site.
- ✘ Attaching the joint tube on top of the KAB, which is installed for sealing the connection floor level - wall. Pay special attention to ensure a distance of approx. 5 cm between the bottom line of joint tube and the horizontal construction joint.
- ✘ During installation, the joint tube has to be fixed on the top. At side beads of the smooth crack inducer, fixations have to be carried out by clamps and nealed wire, to center the joint tube in the middle of the butt joint of the pre - cast wall elements. With the boring of the crack inducer behind the side beads, the tube also can be fixed directly with nealed wire.
- ✘ Important for functionality is, that the joint tube has to be concreted accurately, to ensure a correctly embedding of the root point, we recommend the application of small granular, free flowing concrete. The height of fall of the concrete should not exceed 50 cm. The concrete has to be compressed.
- ✘ Concrete has to be brought into the formwork evenly and simultaneously on both sides of the joint tube.
- ✘ Do not extract the inner pipe after concreting.
- ✘ The joint tube has to be filled with concrete during or after concreting the wall.

**Standard intersection pieces**  
leg length 0,50 m (dimension between axes)

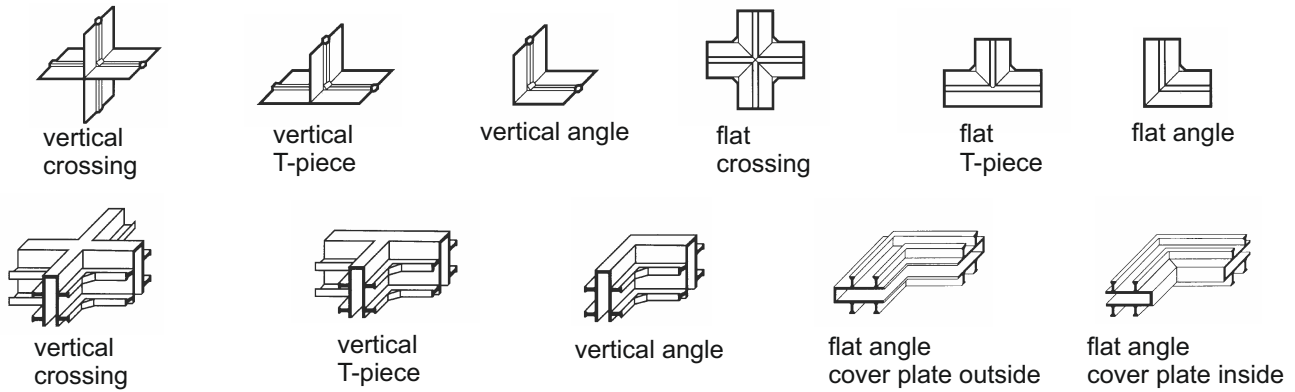

**Waterstop intersection pieces and systems**

On placing an order of standard intersection pieces, quantity, design, type of waterstop and material quality have to be declared.

To design waterstop systems we need -if possible isometric- system drawings with complete dimensions and designation about the type of waterstop and the material quality.

Every declared dimension, has to be dimension between axes.

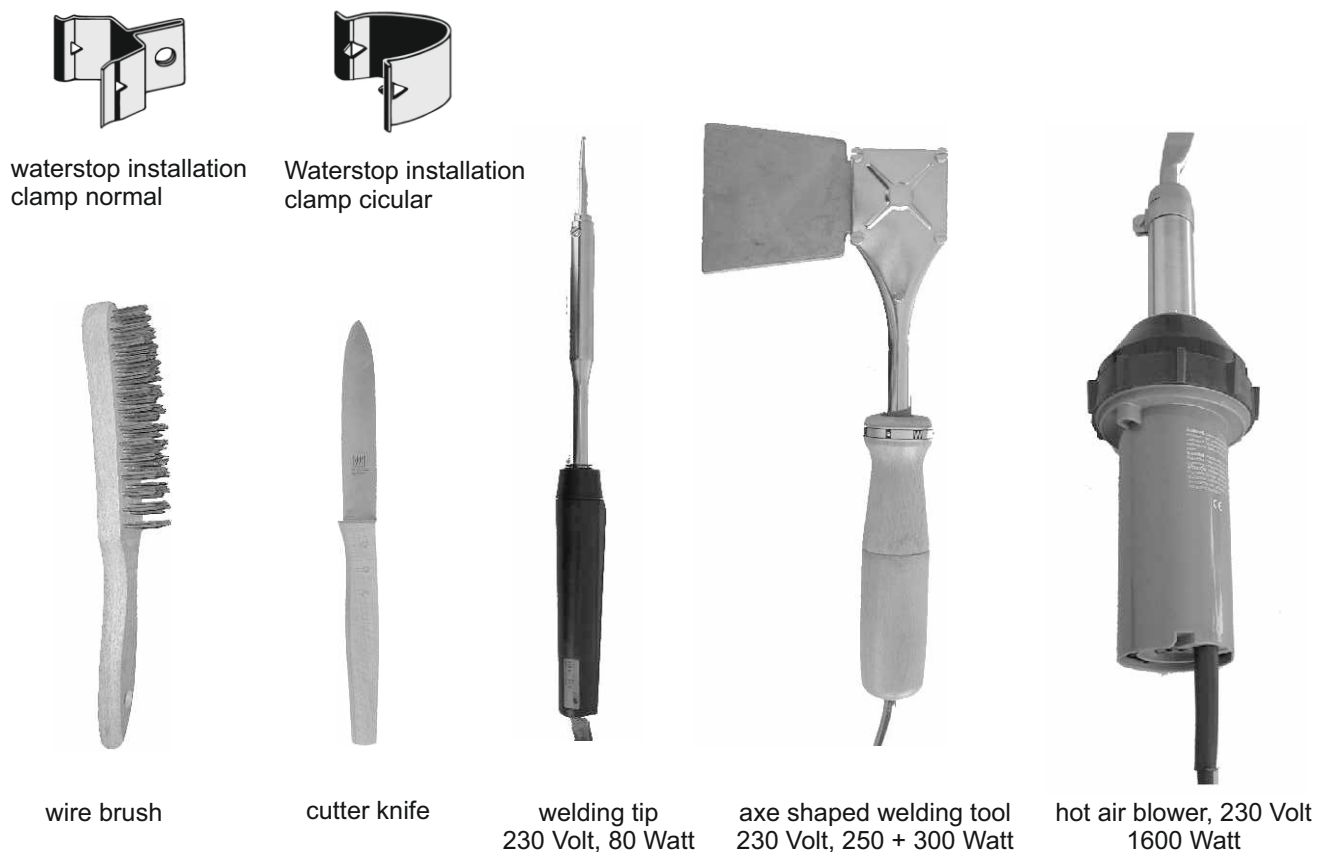

waterstop installation clamp normal

Waterstop installation clamp circular

wire brush

cutter knife

welding tip  
230 Volt, 80 Watt

axe shaped welding tool  
230 Volt, 250 + 300 Watt

hot air blower, 230 Volt  
1600 Watt



The Leschuplast GLT terminal strip is a system to connect internal construction joint waterstops without thermal welding. Basic principle are 3 swelling gasket profiles with a capacity for high volume expansion and terminal strips, which will be connected with the punched waterstop by butterfly nuts.

For punching the waterstop, the terminal strip will be used as a template (5 mm drill bit). In the area of clamping, anchoring ribs and raffle have to be leveled. For construction joint waterstops with fixing loops (SFA), the loops have to be taken off in the area of clamping additional. The swelling gasket profiles will be delivered prepunched and should be stuck together as pictured below. The butterfly nuts should be fixed hand - screwed.

A 240 mounted on A 240

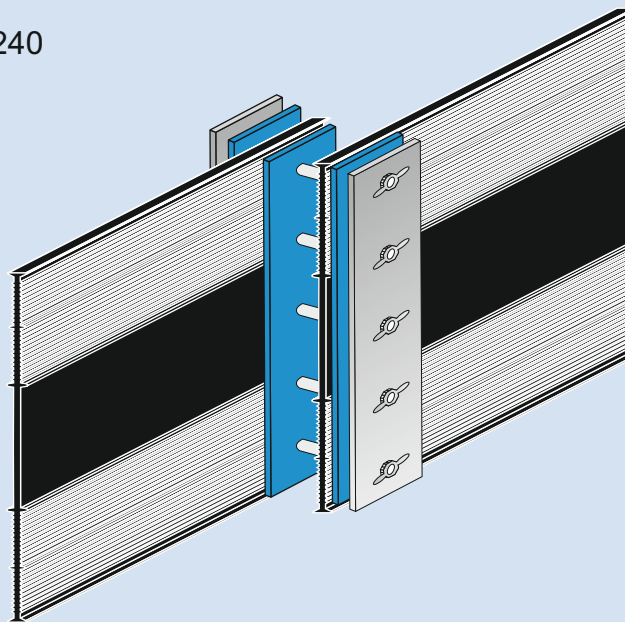

Connection with internal  
expansion joint waterstop

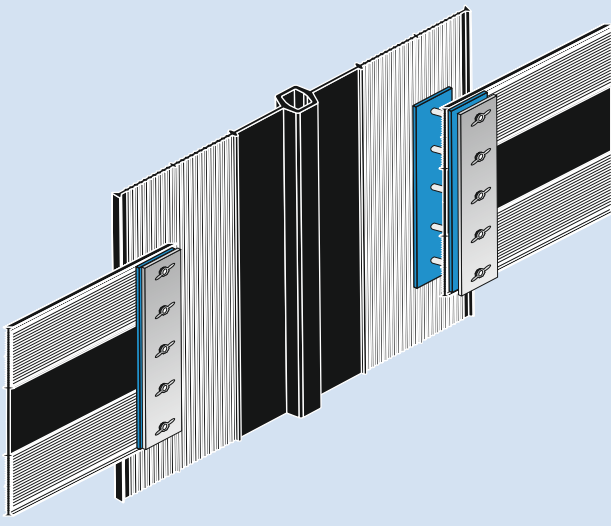

**KS 190**  
suitable for Leschuplast GLT internal construction  
joint waterstop A 19 / A 190 / SFA 19 / SFA 190



**KS 240**  
suitable for Leschuplast GLT internal construction  
joint waterstop A 24 / A 240 / SFA 24 / SFA 240



**KS 320**  
suitable for Leschuplast GLT internal construction  
joint waterstop A 32 / A 320 / SFA 32 / SFA 320

Other widths are available on request.

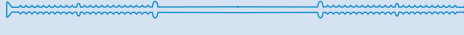
**Appearance:**

Set in a polyethylene bag consisting of:  
terminal strips, prepunched  
swelling gasket profiles, prepunched  
screws M5 with butterfly nuts

pos.	quantity	specification of services	unit price	all round price
	...running meter	<p>Leschuplast GLT <b>combination construction joint waterstop with AbP</b> (General Construction Supervision Certificate), for sealing of construction joints without floor setting edge, consisting of semi-hard PVC-P material and integrated round swelling rubber profile, total width ... mm, incl. steel bars for installation (2 pcs. / m), Leschuplast GLT type <b>KAB ... Set</b></p> <p><b>dimensions page 4</b></p> 		
	...running meter	<p>Leschuplast GLT <b>construction joint waterstop, internal, reinforced LECOTRIL DIN 18541 compatible with bitumen (BV)</b>, with extruded reinforcement and fixing loops (SFA) or internal flat steel bar reinforcement (ISAF), total width ... mm, thickness of expansion part ... mm, Leschuplast GLT type <b>SFA .../ISAF</b></p> <p><b>dimensions page 6</b></p> 		
	...running meter	<p>Leschuplast GLT <b>construction joint waterstop, internal, LECOTRIL DIN 18541 compatible with bitumen (BV)</b>, total width ... mm, thickness of expansion part ... mm, Leschuplast GLT type <b>A...</b></p> <p><b>dimensions page 7</b></p> 		
	...running meter	<p>Leschuplast GLT <b>construction joint waterstop, external, LECOTRIL DIN 18541 compatible with bitumen (BV)</b>, total width ... mm, thickness of expansion part ... mm, quantity of anchoring ribs ... pcs., height of anchoring ribs ... mm, Leschuplast GLT type <b>AA...</b></p> <p><b>dimensions page 8-9</b></p> 		
	...running meter	<p>Leschuplast GLT <b>joint tube with AbP</b> (General Construction Supervision Certificate), for precise controlling and sealing of shrinkage cracks in watertight concrete consisting of harder adjusted PVC soft, with reinforced rigid PVC - U - pipe, diameter ... mm, for concrete cross sections from ... up to ... cm, Leschuplast GLT type <b>Q1 / Q2 / DR 6</b></p> <p><b>dimensions page 10-11</b></p> 		
	...running meter	<p>Leschuplast GLT <b>construction joint waterstop for high demands, internal, LECOTRIL DIN 18541 part 2 compatible with bitumen (BV)</b>, total width ... mm, thickness of expansion part ... mm, Leschuplast GLT type <b>A...</b> Leschuplast GLT type <b>D...</b></p> <p><b>dimensions page 12</b></p> 		

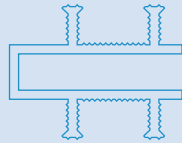
pos.	quantity	specification of services	unit price	all round price
	...running meter	<p>Leschuplast GLT <b>expansion joint waterstop, internal, LECOTRIL DIN 18541 compatible with bitumen (BV)</b>, total width ... mm, thickness of expansion part ... mm, Leschuplast GLT type <b>D</b> ...</p> <p><b>dimensions page 13-14</b></p> 		
	...running meter	<p>Leschuplast GLT <b>expansion joint waterstop, internal, LECOTRIL DIN 18541 compatible with bitumen (BV)</b>, with extruded reinforcement and fixing loops, total width ... mm, thickness of expansion part ... mm, Leschuplast GLT type <b>SFD</b> ...</p> <p><b>dimensions page 14</b></p> 		
	...running meter	<p>Leschuplast GLT <b>expansion joint waterstop, external, LECOTRIL DIN 18541 compatible with bitumen (BV)</b>, total width ... mm, thickness of expansion part ... mm, quantity of anchoring ribs ... pcs., height of anchoring ribs ... mm, Leschuplast GLT type <b>DA</b> ...</p> <p><b>dimensions page 15-16</b></p> 		
	...running meter	<p>Leschuplast GLT <b>waterstop for capping joints, LECOTRIL DIN 18541 compatible with bitumen (BV)</b>, width of sight ... mm, width of joints ... mm, thickness of cover plate ... mm, quantity of anchoring ribs ... pcs., height of anchoring ribs ... mm, Leschuplast GLT type <b>FA</b> ...</p> <p><b>dimensions page 17</b></p> 		
		<p><b>General details:</b></p> <p><b>Angle-, T - piece and crossing - connections always have to be factory - made intersection pieces.</b></p> <p>Butt joints made on building site have to be welded homogeneous, waterproof according to manufacturers' instructions and have to be included into the unit price; Fastening materials won't charged separately. Close adjoining of formwork and possible difficulties from interference by formwork and reinforcement are satisfied with the unit price.</p> <p>Waterstops will be calculated depending on their biggest length (bevel cuts, miters), intersection pieces will be quantified overall.</p>		

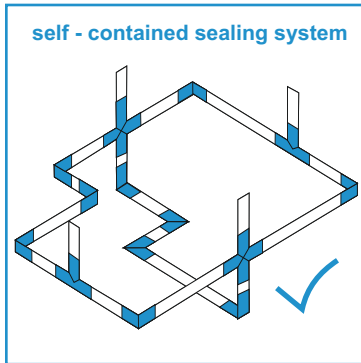

• **Basic principles of planning**

Waterstops, have to result in a self - contained sealing system inside of watertight concrete structures. Crossover of joints among each other as well as crossover with angles and grooves of concrete structure should be preferably perpendicular.

The thickness of units in the area of the waterstop should be in accordance with the width of the waterstop. For 320 mm wide thermoplastic waterstops (type A, AA, D and DA) a thickness of unit about 300 mm is enough. **For construction joints exceptions like KAB (combination construction joint waterstop) are allowed.**

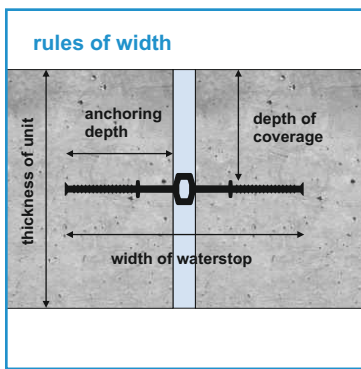

The choice of waterstops, should be considered, against operational demands (movement, distribution pressure, compatibility against medium etc.)

In case of a change in direction, from vertical to horizontal, the waterstops (floor / wall), can be installed, with a radius, under adherence of allowable bending radii according to DIN 18197.

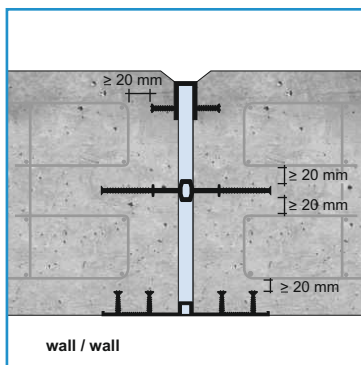

The allover depth of coverage with concrete between waterstop and reinforcement has to be minimum of 20 mm all side.

**For horizontal and low inclined units like floor levels and ceilings, internal waterstops with vee upward - looking side blades with an angle of approx. 10° have to be installed, to enable an embedding of the blades of the waterstop without cavities.**

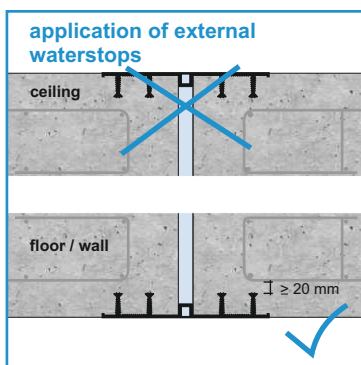

External waterstops, mustn't be concreted, on the upside of horizontal and low inclined units.

Under construction or use, the expectant deformation of the joint width, should not be more than 10 mm.

To protect the joint from contamination, for earth side external waterstops and downstream waterstops, capping joints should be used.

## protected storage



## • Storage

The delivered waterstop has to be unloaded carefully and quantity dated.

Up to the date of installation, waterstops have to be stored on wooden pallets or other rigid boards in a sheltered position and be protected against contamination and damage.

Thermoplastic waterstops should be stored preferably in a stack and should be stored in hot rooms at least one day before processing.

## cleanness and intactness

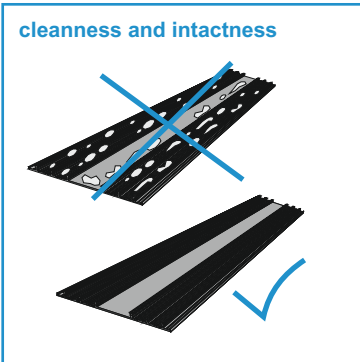

## • Installation and fastening

Thermoplastic waterstops may only be installed if they don't show any deformations or damaging, which could effect their function.

Waterstops have to be kept free from contamination and ice - formation during concreting.

## Construction joint floor/wall

waterstop installation clamp

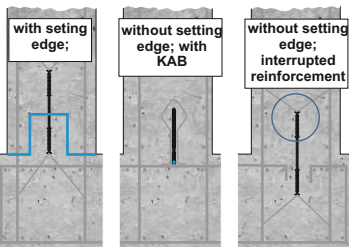

Waterstops have to be installed free of creases and warping. Deformations caused by storage or during shipment to thermoplastic waterstops, have to be remedied, by stretch forming or heat treatment.

Waterstops have to be installed symmetrically to the axis of joints and fastened so that their position cannot be displaced during concreting.

## blade angle for floor levels and ceilings

waterstop installation clamp

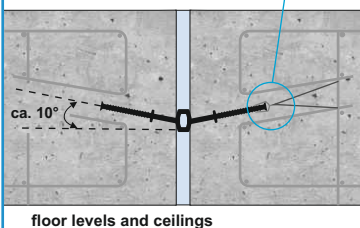
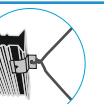

Internal construction joint waterstops in the area floor / wall can be installed with or without setting edge. In case of installation without setting edge, the upper reinforcement have to be interrupted. **By using KAB (combination construction joint waterstop) setting edge and interruption of reinforcement is not necessary.**

Internal waterstops have to be anchored at reinforcement. The fastening of waterstops (at least every 25 cm) take place at margin anchoring ribs with waterstop installation clamps. To prevent cavities, internal waterstops inside of floor levels and ceilings have to be installed with vee upward looking side blades, with an angle of approx. 10°.

floor levels and ceilings

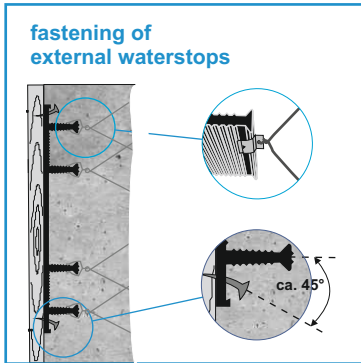

External waterstops for walls have to be fastened in margin area with nails at the formwork. The anchoring ribs have to be fixed at the reinforcement, holding steady in position by using waterstop installation clamps. In case of horizontal installation, external waterstops have to be fixed on the sub-grade course.

The distance between two join patches should be bigger than 0,50 m. In case of change of directions or crossings of joints, factory-made intersection pieces or systems in accordance to the run of joints should be used.

During setting up the formwork for the waterstop, pay special attention to the leak proofness and steady holding in position of the bulkhead formwork. The stop end of the formwork has to be attached close to the waterstop.

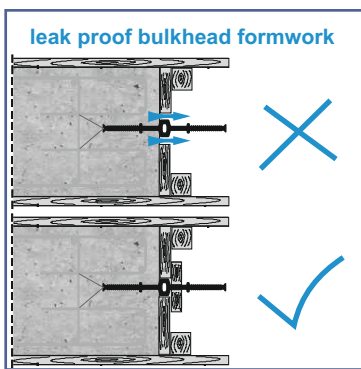

- **Concreting**

Before concreting, waterstops should be cleaned. Waterstops have to be set in concrete and completely embedded, without cavities. Sealing function can be assured, if these procedures are followed.

The waterstops have to be protected against damage e.g. by free ends of reinforcement or following workings up to the date of complete setting in concrete.

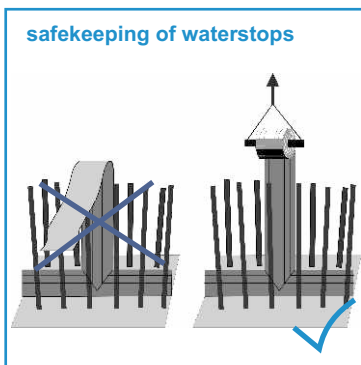

During compression of the unset concrete, the waterstop and it's fastening mustn't be touched by the internal compacter. In case of external waterstops, possibly external compactors have to be used.

- **Stripping the forms**

For external waterstops, during stripping the formworks, pay special attention that the waterstop won't be loosened. Maybe the time limit of stripping the forms has to be extended.

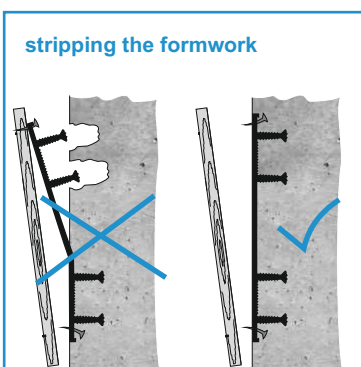

After stripping the formwork, the visible areas of waterstops have to be checked for damage and noticed faults have to be remedied immediately.

The application of waterstops on building site as well as their processing and installation have to be controlled and documented.

**As a basic principle the DIN 18197 is valid for planning, dimensioning, conditioning, processing and installation of waterstops.**

**Information applications**

All details contained in this brochure are product descriptions. They are general recommendations based on extensive research and practical experience but do not consider the actual application work. No indemnities may be claimed from the given information.

If necessary, please contact our technical department for more information. If required for specific applications, additional tests can be conducted in our laboratory as supplement to the standard tests and the normal material compatibility information.

**Technical changes**

We reserve the right to alter either the form of the profiles or the material properties in case of new technical developments.

**Recommendations for use technical indications**

Our information and recommendations have to be considered.

**Measurements Tolerances**

All dimensions are quoted in mm. Differences in the dimensions are in accordance to DIN 16941, table 3A + 3B. For waterstops according to DIN 18541, the quoted dimensions are minimum sizes.

**Terms of business**

Our general conditions for sale and delivery are valid.

**Copyright**

© 2013; Leschuplast GLT GmbH & Co. KG, Bergisch Gladbach

All rights reserved. Reproduction even in extracts only upon authorisation.

# Cross section of a multifloor building in watertight concrete with sliding support

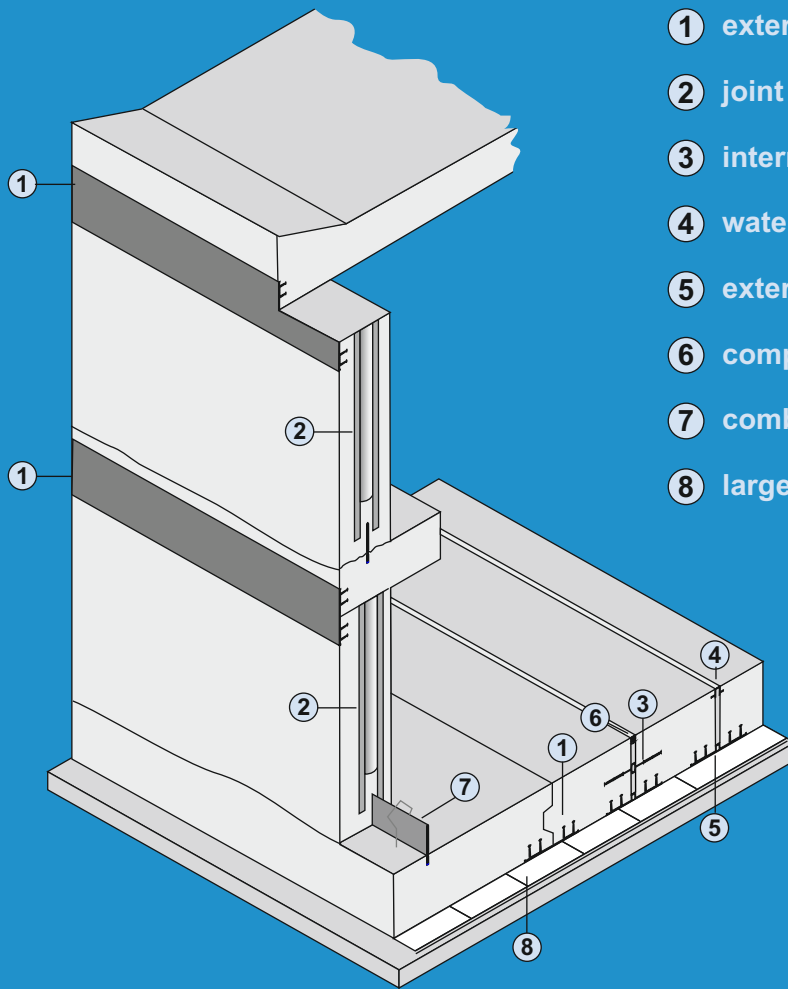

- ① external construction joint waterstop
- ② joint tube
- ③ internal expansion joint waterstop
- ④ waterstop for capping joints
- ⑤ external expansion joint waterstop
- ⑥ compression seal
- ⑦ combination construction joint waterstop
- ⑧ large - area sliding foil

distribution:

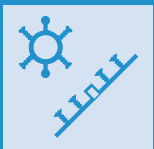

## waterproofing systems

- X waterstops
- X KAB - waterstops
- X joint tubes
- X swelling sealing products



## sliding- and bearing technology

- X sliding foils
- X elastomer bearings
- X sound damping bearings
- X slide bearings

**Leschuplast GLT  
GmbH & Co. KG**  
Refrather Weg 42 - 44  
51469 Bergisch Gladbach  
Germany

Tel: +49 (0)2202 / 9 27 55 - 0 • Fax: +49 (0)2202 / 9 27 55 - 90 • e-mail: [info@leschuplast-glt.de](mailto:info@leschuplast-glt.de)